



**OM-188 360**

April 1997

Eff. w/Style Number KH17

**Processes**



Automatic Welding

**Description**



Automatic Welding System

# Touch Sensor w/Contactor

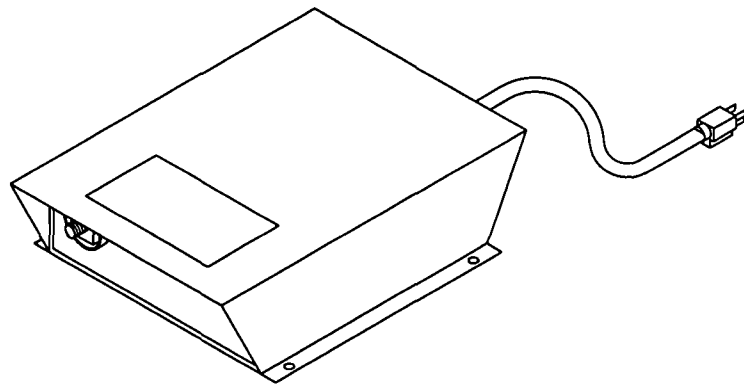

Visit our website at  
[www.millerwelds.com](http://www.millerwelds.com)

**OWNER'S MANUAL**



# From Miller to You

*Thank you and congratulations* on choosing Miller. Now you can get the job done and get it done right. We know you don't have time to do it any other way.

That's why when Niels Miller first started building arc welders in 1929, he made sure his products offered long-lasting value and superior quality. Like you, his customers couldn't afford anything less. Miller products had to be more than the best they could be. They had to be the best you could buy.

Today, the people that build and sell Miller products continue the tradition. They're just as committed to providing equipment and service that meets the high standards of quality and value established in 1929.

This Owner's Manual is designed to help you get the most out of your Miller products. Please take time to read the Safety precautions. They will help you protect yourself against potential hazards on the worksite. We've

made installation and operation quick and easy. With Miller you can count on years of reliable service with proper maintenance. And if for some reason the unit needs repair, there's a Troubleshooting section that will help you figure out what the problem is. The parts list will then help you to decide which exact part you may need to fix the problem. Warranty and service information for your particular model are also provided.



**Miller is the first welding equipment manufacturer in the U.S.A. to be registered to the ISO 9001 Quality System Standard.**

Miller Electric manufactures a full line of welders and welding related equipment. For information on other quality Miller products, contact your local Miller distributor to receive the latest full line catalog or individual catalog sheets. To locate your nearest distributor call 1-800-4-A-Miller.

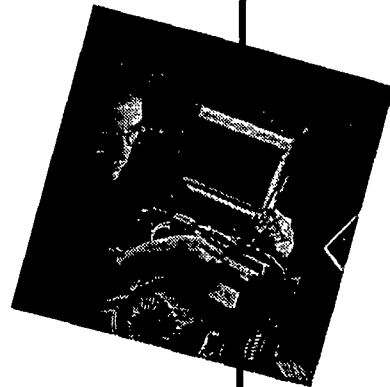

**Working as hard as you do – every power source from Miller is backed by the most hassle-free warranty in the business.**





# Touch Sensor w/Contactor

## Description



The Touch Sensor is designed to provide touch sensing capability using the welding wire and voltage sense leads. The robot controller sends a signal to the Touch Sensor to begin touch sensing operation. A signal is sent from the Touch Sensor to the robot controller when the welding wire touches the weldment.

The contactor in the Touch Sensor prevents any low impedance path through the welding power source during touch sensing operation. It also operates during the weld cycle by closing before welding begins and remains closed during the welding operation by sensing weld current. When no weld current is detected, the contactor deenergizes.

## Features

- 115 VAC, 2 A, 60 Hz Input Power
- 170 VDC, 5 mA Touch Sense Output
- Touch Sensor And Input Power Pilot Lights
- External Connections For Cords And Cables
- Product features and specifications are subject to change without notice

## Processes



Automatic Welding

**Call  
1-800-4-A-MILLER  
for your local  
Miller distributor.**

Your distributor gives you ...

### Service

You always get the fast, reliable response you need. Most replacement parts can be in your hands in 24 hours.

### Support

Need fast answers to the tough welding questions? Contact your distributor. The expertise of the distributor and Miller is there to help you, every step of the way.

## Table of Contents

Section	Page
1. Safety Precautions .....	1
1. Consignes de sécurité .....	5
2. Introduction .....	9
3. Installation .....	9
4. Operation .....	12
5. Maintenance and Troubleshooting .....	12
6. Electrical Diagram .....	14
7. Parts List .....	16

### Warranty

Miller offers a Technical Manual which provides more detailed service and parts information for your unit. To obtain a Technical Manual, contact your local distributor. Your distributor can also supply you with Welding Process Manuals such as SMAW, GTAW, GMAW, and GMAW-P.

For practical information on welding, process applications, and Miller products, visit our website at

[www.millerwelds.com](http://www.millerwelds.com)









# 1. Safety Precautions – Read Before Using

## 1.1 Symbol Usage

OM-186 360 - 4/97, safety\_som 4/97



Means Warning! Watch Out! There are possible hazards with this procedure! The possible hazards are shown in the adjoining symbols.

▲ Marks a special safety message.

☞ Means "Note"; not safety related.



This group of symbols means Warning! Watch Out! possible ELECTRIC SHOCK, MOVING PARTS, and HOT PARTS hazards. Consult symbols and related instructions below for necessary actions to avoid the hazards.

## 1.2 Arc Welding Hazards

▲ The symbols shown below are used throughout this manual to call attention to and identify possible hazards. When you see the symbol, watch out, and follow the related instructions to avoid the hazard. The safety information given below is only a summary of the more complete safety information found in the Safety Standards listed in Section 1.4. Read and follow all Safety Standards.

▲ Only qualified persons should install, operate, maintain, and repair this unit.

▲ During operation, keep everybody, especially children, away.



### ELECTRIC SHOCK can kill.

Touching live electrical parts can cause fatal shocks or severe burns. The electrode and work circuit is electrically live whenever the output is on. The input power circuit and machine internal circuits are also live when power is on. In semiautomatic or automatic wire welding, the wire, wire reel, drive roll housing, and all metal parts touching the welding wire are electrically live. Incorrectly installed or improperly grounded equipment is a hazard.

- Do not touch live electrical parts.
- Wear dry, hole-free insulating gloves and body protection.
- Insulate yourself from work and ground using dry insulating mats or covers big enough to prevent any physical contact with the work or ground.
- Do not use AC output in damp areas, if movement is confined, or if there is a danger of falling.
- Use AC output ONLY if required for the welding process.
- If AC output is required, use remote output control if present on unit.
- Disconnect input power or stop engine before installing or servicing this equipment. Lockout/tagout input power according to OSHA 29 CFR 1910.147 (see Safety Standards).
- Properly install and ground this equipment according to its Owner's Manual and national, state, and local codes.
- Always verify the supply ground – check and be sure that input power cord ground wire is properly connected to ground terminal in disconnect box or that cord plug is connected to a properly grounded receptacle outlet.
- When making input connections, attach proper grounding conductor first – double-check connections.
- Frequently inspect input power cord for damage or bare wiring – replace cord immediately if damaged – bare wiring can kill.
- Turn off all equipment when not in use.
- Do not use worn, damaged, undersized, or poorly spliced cables.

- Do not drape cables over your body.
- If earth grounding of the workpiece is required, ground it directly with a separate cable – do not use work clamp or work cable.
- Do not touch electrode if you are in contact with the work, ground, or another electrode from a different machine.
- Use only well-maintained equipment. Repair or replace damaged parts at once. Maintain unit according to manual.
- Wear a safety harness if working above floor level.
- Keep all panels and covers securely in place.
- Clamp work cable with good metal-to-metal contact to workpiece or worktable as near the weld as practical.
- Insulate work clamp when not connected to workpiece to prevent contact with any metal object.

### SIGNIFICANT DC VOLTAGE exists after removal of input power on inverters.

- Turn Off inverter, disconnect input power, and discharge input capacitors according to instructions in Maintenance Section before touching any parts.



### FUMES AND GASES can be hazardous.

Welding produces fumes and gases. Breathing these fumes and gases can be hazardous to your health.

- Keep your head out of the fumes. Do not breathe the fumes.
- If inside, ventilate the area and/or use exhaust at the arc to remove welding fumes and gases.
- If ventilation is poor, use an approved air-supplied respirator.
- Read the Material Safety Data Sheets (MSDSs) and the manufacturer's instructions for metals, consumables, coatings, cleaners, and degreasers.
- Work in a confined space only if it is well ventilated, or while wearing an air-supplied respirator. Always have a trained watch-person nearby. Welding fumes and gases can displace air and lower the oxygen level causing injury or death. Be sure the breathing air is safe.
- Do not weld in locations near degreasing, cleaning, or spraying operations. The heat and rays of the arc can react with vapors to form highly toxic and irritating gases.
- Do not weld on coated metals, such as galvanized, lead, or cadmium plated steel, unless the coating is removed from the weld area, the area is well ventilated, and if necessary, while wearing an air-supplied respirator. The coatings and any metals containing these elements can give off toxic fumes if welded.





### **ARC RAYS can burn eyes and skin.**

Arc rays from the welding process produce intense visible and invisible (ultraviolet and infrared) rays that can burn eyes and skin. Sparks fly off from the weld.

- Wear a welding helmet fitted with a proper shade of filter to protect your face and eyes when welding or watching (see ANSI Z49.1 and Z87.1 listed in Safety Standards).
- Wear approved safety glasses with side shields under your helmet.
- Use protective screens or barriers to protect others from flash and glare; warn others not to watch the arc.
- Wear protective clothing made from durable, flame-resistant material (leather and wool) and foot protection.



### **WELDING can cause fire or explosion.**

Welding on closed containers, such as tanks, drums, or pipes, can cause them to blow up. Sparks can fly off from the welding arc. The flying sparks, hot workpiece, and hot equipment can cause fires and burns. Accidental contact of electrode to metal objects can cause sparks, explosion, overheating, or fire. Check and be sure the area is safe before doing any welding.

- Protect yourself and others from flying sparks and hot metal.
- Do not weld where flying sparks can strike flammable material.
- Remove all flammables within 35 ft (10.7 m) of the welding arc. If this is not possible, tightly cover them with approved covers.
- Be alert that welding sparks and hot materials from welding can easily go through small cracks and openings to adjacent areas.
- Watch for fire, and keep a fire extinguisher nearby.
- Be aware that welding on a ceiling, floor, bulkhead, or partition can cause fire on the hidden side.
- Do not weld on closed containers such as tanks, drums, or pipes, unless they are properly prepared according to AWS F4.1 (see Safety Standards).
- Connect work cable to the work as close to the welding area as practical to prevent welding current from traveling long, possibly unknown paths and causing electric shock and fire hazards.
- Do not use welder to thaw frozen pipes.
- Remove stick electrode from holder or cut off welding wire at contact tip when not in use.
- Wear oil-free protective garments such as leather gloves, heavy shirt, cuffless trousers, high shoes, and a cap.
- Remove any combustibles, such as a butane lighter or matches, from your person before doing any welding.

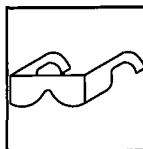

### **FLYING METAL can injure eyes.**

- Welding, chipping, wire brushing, and grinding cause sparks and flying metal. As welds cool, they can throw off slag.
- Wear approved safety glasses with side shields even under your welding helmet.



### **BUILDUP OF GAS can injure or kill.**

- Shut off shielding gas supply when not in use.
- Always ventilate confined spaces or use approved air-supplied respirator.



### **HOT PARTS can cause severe burns.**

- Do not touch hot parts bare handed.
- Allow cooling period before working on gun or torch.



### **MAGNETIC FIELDS can affect pacemakers.**

- Pacemaker wearers keep away.
- Wearers should consult their doctor before going near arc welding, gouging, or spot welding operations.

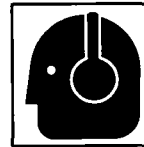

### **NOISE can damage hearing.**

Noise from some processes or equipment can damage hearing.

- Wear approved ear protection if noise level is high.



### **CYLINDERS can explode if damaged.**

Shielding gas cylinders contain gas under high pressure. If damaged, a cylinder can explode. Since gas cylinders are normally part of the welding process, be sure to treat them carefully.

- Protect compressed gas cylinders from excessive heat, mechanical shocks, slag, open flames, sparks, and arcs.
- Install cylinders in an upright position by securing to a stationary support or cylinder rack to prevent falling or tipping.
- Keep cylinders away from any welding or other electrical circuits.
- Never drape a welding torch over a gas cylinder.
- Never allow a welding electrode to touch any cylinder.
- Never weld on a pressurized cylinder – explosion will result.
- Use only correct shielding gas cylinders, regulators, hoses, and fittings designed for the specific application; maintain them and associated parts in good condition.
- Turn face away from valve outlet when opening cylinder valve.
- Keep protective cap in place over valve except when cylinder is in use or connected for use.
- Read and follow instructions on compressed gas cylinders, associated equipment, and CGA publication P-1 listed in Safety Standards.



## 1.3 Additional Symbols for Installation, Operation, and Maintenance



### FIRE OR EXPLOSION hazard.

- Do not install or place unit on, over, or near combustible surfaces.
- Do not install unit near flammables.
- Do not overload building wiring – be sure power supply system is properly sized, rated, and protected to handle this unit.



### MOVING PARTS can cause injury.

- Keep away from moving parts such as fans.
- Keep all doors, panels, covers, and guards closed and securely in place.



### FALLING UNIT can cause injury.

- Use lifting eye to lift unit only, NOT running gear, gas cylinders, or any other accessories.
- Use equipment of adequate capacity to lift and support unit.
- If using lift forks to move unit, be sure forks are long enough to extend beyond opposite side of unit.

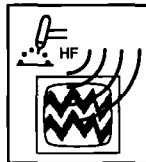

### H.F. RADIATION can cause Interference.

- High-frequency (H.F.) can interfere with radio navigation, safety services, computers, and communications equipment.
- Have only qualified persons familiar with electronic equipment perform this installation.
- The user is responsible for having a qualified electrician promptly correct any interference problem resulting from the installation.
- If notified by the FCC about interference, stop using the equipment at once.
- Have the installation regularly checked and maintained.
- Keep high-frequency source doors and panels tightly shut, keep spark gaps at correct setting, and use grounding and shielding to minimize the possibility of interference.

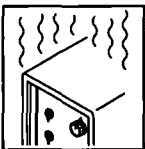

### OVERUSE can cause OVERHEATING

- Allow cooling period; follow rated duty cycle.
- Reduce current or reduce duty cycle before starting to weld again.
- Do not block or filter airflow to unit.



### STATIC (ESD) can damage PC boards.

- Put on grounded wrist strap BEFORE handling boards or parts.
- Use proper static-proof bags and boxes to store, move, or ship PC boards.



### MOVING PARTS can cause injury.

- Keep away from moving parts.
- Keep away from pinch points such as drive rolls.



### WELDING WIRE can cause injury.

- Do not press gun trigger until instructed to do so.
- Do not point gun toward any part of the body, other people, or any metal when threading welding wire.



### ARC WELDING can cause interference.

- Electromagnetic energy can interfere with sensitive electronic equipment such as computers and computer-driven equipment such as robots.
- Be sure all equipment in the welding area is electromagnetically compatible.
- To reduce possible interference, keep weld cables as short as possible, close together, and down low, such as on the floor.
- Locate welding operation 100 meters from any sensitive electronic equipment.
- Be sure this welding machine is installed and grounded according to this manual.
- If interference still occurs, the user must take extra measures such as moving the welding machine, using shielded cables, using line filters, or shielding the work area.

## 1.4 Principal Safety Standards

*Safety in Welding and Cutting*, ANSI Standard Z49.1, from American Welding Society, 550 N.W. LeJeune Rd, Miami FL 33126

*Safety and Health Standards*, OSHA 29 CFR 1910, from Superintendent of Documents, U.S. Government Printing Office, Washington, D.C. 20402.

*Recommended Safe Practices for the Preparation for Welding and Cutting of Containers That Have Held Hazardous Substances*, American Welding Society Standard AWS F4.1, from American Welding Society, 550 N.W. LeJeune Rd, Miami, FL 33126

*National Electrical Code*, NFPA Standard 70, from National Fire Protection Association, Batterymarch Park, Quincy, MA 02269.

*Safe Handling of Compressed Gases in Cylinders*, CGA Pamphlet P-1, from Compressed Gas Association, 1235 Jefferson Davis Highway, Suite 501, Arlington, VA 22202.

*Code for Safety in Welding and Cutting*, CSA Standard W117.2, from Canadian Standards Association, Standards Sales, 178 Rexdale Boulevard, Rexdale, Ontario, Canada M9W 1R3.

*Safe Practices For Occupation And Educational Eye And Face Protection*, ANSI Standard Z87.1, from American National Standards Institute, 1430 Broadway, New York, NY 10018.

*Cutting And Welding Processes*, NFPA Standard 51B, from National Fire Protection Association, Batterymarch Park, Quincy, MA 02269.



## 1.5 EMF Information

### Considerations About Welding And The Effects Of Low Frequency Electric And Magnetic Fields

The following is a quotation from the General Conclusions Section of the U.S. Congress, Office of Technology Assessment, *Biological Effects of Power Frequency Electric & Magnetic Fields – Background Paper*, OTA-BP-E-53 (Washington, DC: U.S. Government Printing Office, May 1989): ". . . there is now a very large volume of scientific findings based on experiments at the cellular level and from studies with animals and people which clearly establish that low frequency magnetic fields can interact with, and produce changes in, biological systems. While most of this work is of very high quality, the results are complex. Current scientific understanding does not yet allow us to interpret the evidence in a single coherent framework. Even more frustrating, it does not yet allow us to draw definite conclusions about questions of possible risk or to offer clear science-based advice on strategies to minimize or avoid potential risks."

To reduce magnetic fields in the workplace, use the following procedures:

1. Keep cables close together by twisting or taping them.
2. Arrange cables to one side and away from the operator.
3. Do not coil or drape cables around the body.
4. Keep welding power source and cables as far away from operator as practical.
5. Connect work clamp to workpiece as close to the weld as possible.

#### **About Pacemakers:**

The above procedures are also recommended for pacemaker wearers. Consult your doctor for complete information.





# 1. Consignes de sécurité – lire avant utilisation

## 1.1 Signification des symboles

OM-186 360 - 4/97, safety\_som\_fre 3/97



Signifie Mise en garde ! Soyez vigilant ! Cette procédure présente des risques de danger ! Ceux-ci sont identifiés par des symboles adjacents aux directives.

▲ Identifie un message de sécurité particulier.

☞ Signifie NOTA ; n'est pas relatif à la sécurité.



Ce groupe de symboles signifie Mise en garde ! Soyez vigilant ! Il y a des risques de danger reliés aux CHOCs ÉLECTRIQUES, aux PIÈCES EN MOUVEMENT et aux PIÈCES CHAUDES. Reportez-vous aux symboles et aux directives ci-dessous afin de connaître les mesures à prendre pour éviter tout danger.

## 1.2 Dangers relatifs au soudage à l'arc

▲ Les symboles présentés ci-après sont utilisés tout au long du présent manuel pour attirer votre attention et identifier les risques de danger. Lorsque vous voyez un symbole, soyez vigilant et suivez les directives mentionnées afin d'éviter tout danger. Les consignes de sécurité présentées ci-après ne font que résumer l'information contenue dans les normes de sécurité énumérées à la section 1-5. Veuillez lire et respecter toutes ces normes de sécurité.

▲ L'installation, l'utilisation, l'entretien et les réparations ne doivent être confiés qu'à des personnes qualifiées.

▲ Au cours de l'utilisation, tenir toute personne à l'écart et plus particulièrement les enfants.

- N'utiliser qu'un matériel en bon état. Réparer ou remplacer sur-le-champ les pièces endommagées. Entretien l'appareil conformément à ce manuel.
- Porter un harnais de sécurité quand on travaille en hauteur.
- Maintenir solidement en place tous les panneaux et capots.
- Fixer le câble de retour de façon à obtenir un bon contact métal-métal avec la pièce à souder ou la table de travail, le plus près possible de la soudure.
- Ranger et isoler correctement la pince de masse après utilisation pour éviter le contact avec des objets reliés à la masse.



### UN CHOC ÉLECTRIQUE peut tuer.

Un simple contact avec des pièces électriques peut provoquer une électrocution ou des blessures graves. L'électrode et le circuit de soudage sont sous tension dès que l'appareil est sur ON. Le circuit d'entrée et les circuits internes de l'appareil sont également sous

tension à ce moment-là. En soudage semi-automatique ou automatique, le fil, le dévidoir, le logement des galets d'entraînement et les pièces métalliques en contact avec le fil de soudage sont sous tension. Des matériels mal installés ou mal mis à la terre présentent un danger.

- Ne jamais toucher les pièces électriques sous tension.
- Porter des gants et des vêtements de protection secs ne comportant pas de trous.
- S'isoler de la pièce et de la terre au moyen de tapis ou d'autres moyens isolants suffisamment grands pour empêcher le contact physique éventuel avec la pièce ou la terre.
- Ne pas se servir de source électrique à courant électrique dans les zones humides, dans les endroits confinés ou là où on risque de tomber.
- Se servir d'une source électrique à courant électrique UNIQUEMENT si le procédé de soudage le demande.
- Si l'utilisation d'une source électrique à courant électrique s'avère nécessaire, se servir de la fonction de télécommande si l'appareil en est équipé.
- Couper l'alimentation ou arrêter le moteur avant de procéder à l'installation, à la réparation ou à l'entretien de l'appareil. Déverrouiller l'alimentation selon la norme OSHA 29 CFR 1910.147 (voir normes de sécurité).
- Installer et mettre à la terre correctement cet appareil conformément à son manuel d'utilisation et aux codes nationaux, provinciaux et municipaux.
- Toujours vérifier la terre du cordon d'alimentation – Vérifier et s'assurer que le fil de terre du cordon d'alimentation est bien raccordé à la borne de terre du sectionneur ou que la fiche du cordon est raccordée à une prise correctement mise à la terre.
- En effectuant les raccordements d'entrée fixer d'abord le conducteur de mise à la terre approprié et contre-vérifier les connexions.
- Vérifier fréquemment le cordon d'alimentation pour voir s'il n'est pas endommagé ou dénudé – remplacer le cordon immédiatement s'il est endommagé – un câble dénudé peut provoquer une électrocution.
- Mettre l'appareil hors tension quand on ne l'utilise pas.
- Ne pas utiliser des câbles usés, endommagés, de grosseur insuffisante ou mal épaissés.
- Ne pas enrouler les câbles autour du corps.
- Si la pièce soudée doit être mise à la terre, la faire directement avec un câble distinct – ne pas utiliser le connecteur de pièce ou le câble de retour.
- Ne pas toucher l'électrode quand on est en contact avec la pièce, la terre ou une électrode provenant d'une autre machine.

Il y a DU COURANT CONTINU IMPORTANT dans les convertisseurs après la suppression de l'alimentation électrique.

- Arrêter les convertisseurs, débrancher le courant électrique, et décharger les condensateurs d'alimentation selon les instructions indiquées dans la partie entretien avant de toucher les pièces.



### LES FUMÉES ET LES GAZ peuvent être dangereux.

Le soudage génère des fumées et des gaz. Leur inhalation peut être dangereuse pour votre santé.

- Eloigner votre tête des fumées. Ne pas respirer les fumées.
- A l'intérieur, ventiler la zone et/ou utiliser un échappement au niveau de l'arc pour l'évacuation des fumées et des gaz de soudage.
- Si la ventilation est insuffisante, utiliser un respirateur à alimentation d'air homologué.
- Lire les spécifications de sécurité des matériaux (MSDSs) et les instructions du fabricant concernant les métaux, les consommables, les revêtements, les nettoyants et les dégraissants.
- Travailler dans un espace fermé seulement s'il est bien ventilé ou en portant un respirateur à alimentation d'air. Demander toujours à un surveillant dûment formé de se tenir à proximité. Des fumées et des gaz de soudage peuvent déplacer l'air et abaisser le niveau d'oxygène provoquant des blessures ou des accidents mortels. S'assurer que l'air de respiration ne présente aucun danger.
- Ne pas souder dans des endroits situés à proximité d'opérations de dégraissage, de nettoyage ou de pulvérisation. La chaleur et les rayons de l'arc peuvent réagir en présence de vapeurs et former des gaz hautement toxiques et irritants.
- Ne pas souder des métaux munis d'un revêtement, tels que l'acier galvanisé, plaqué en plomb ou au cadmium à moins que le revêtement n'ait été enlevé dans la zone de soudure, que l'endroit soit bien ventilé, et si nécessaire, en portant un respirateur à alimentation d'air. Les revêtements et tous les métaux renfermant ces éléments peuvent dégager des fumées toxiques en cas de soudage.





### LES RAYONS DE L'ARC peuvent provoquer des brûlures dans les yeux et sur la peau.

Le rayonnement de l'arc du procédé de soudage génère des rayons visibles et invisibles intenses (ultraviolets et infrarouges) susceptibles de provoquer des brûlures dans les yeux et sur la peau. Des étincelles sont projetées pendant le soudage.

- Porter un casque de soudage muni d'un écran de filtre approprié pour protéger votre visage et vos yeux pendant le soudage ou pour regarder (voir ANSI Z49.1 et Z87.1 énuméré dans les normes de sécurité).
- Porter des protections approuvés pour les oreilles si le niveau sonore est trop élevé.
- Utiliser des écrans ou des barrières pour protéger des tiers de l'éclair et de l'éblouissement; demander aux autres personnes de ne pas regarder l'arc.
- Porter des vêtements de protection constitué dans une matière durable, résistant au feu (cuir ou laine) et une protection des pieds.



### LE SOUDAGE peut provoquer un incendie ou une explosion.

Le soudage effectué sur des contenants fermés tels que des réservoirs, tambours ou des conduites peut provoquer leur éclatement. Des étincelles peuvent être projetées de l'arc de soudure. La projection d'étincelles, des pièces chaudes et des équipements chauds peut provoquer des incendies et des brûlures. Le contact accidentel de l'électrode avec des objets métalliques peut provoquer des étincelles, une explosion, un surchauffement ou un incendie. Avant de commencer le soudage, vérifier et s'assurer que l'endroit ne présente pas de danger.

- Se protéger et d'autres personnes de la projection d'étincelles et de métal chaud.
- Ne pas souder dans un endroit où des étincelles peuvent tomber sur des substances inflammables.
- Déplacer toutes les substances inflammables à une distance de 10,7 m de l'arc de soudage. En cas d'impossibilité les recouvrir soigneusement avec des protections homologués.
- Des étincelles et des matériaux chauds du soudage peuvent facilement passer dans d'autres zones en traversant de petites fissures et des ouvertures.
- Surveiller tout déclenchement d'incendie et tenir un extincteur à proximité.
- Le soudage effectué sur un plafond, plancher, paroi ou séparation peut déclencher un incendie de l'autre côté.
- Ne pas effectuer le soudage sur des contenants fermés tels que des réservoirs, tambours, ou conduites, à moins qu'ils n'aient été préparés correctement conformément à AWS F4.1 (voir les normes de sécurité).
- Brancher le câble sur la pièce le plus près possible de la zone de soudage pour éviter le transport du courant sur une longue distance par des chemins inconnus éventuels en provoquant des risques d'électrocution et d'incendie.
- Ne pas utiliser le poste de soudage pour dégeler des conduites gelées.
- En cas de non utilisation, enlever la baguette d'électrode du porte-électrode ou couper le fil à la pointe de contact.
- Porter des vêtements de protection dépourvus d'huile tels que des gants en cuir, une chemise en matériau lourd, des pantalons sans revers, des chaussures hautes et un couvre chef.
- Avant de souder, retirer toute substance combustible de vos poches telles qu'un allumeur au butane ou des allumettes.

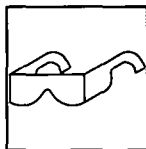

### DES PARTICULES VOLANTES peuvent blesser les yeux.

- Le soudage, l'écaillage, le passage de la pièce à la brosse en fil de fer, et le meulage génèrent des étincelles et des particules métalliques volantes.

Pendant la période de refroidissement des soudures, elles risquent de projeter du laitier.

- Porter des lunettes de sécurité avec écrans latéraux ou un écran facial.



### LES ACCUMULATIONS DE GAZ risquent de provoquer des blessures ou même la mort.

- Fermer l'alimentation du gaz protecteur en cas de non utilisation.
- Veiller toujours à bien aérer les espaces confinés ou se servir d'un respirateur d'adduction d'air homologué.

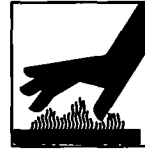

### DES PIÈCES CHAUDES peuvent provoquer des brûlures graves.

- Ne pas toucher des parties chaudes à mains nues
- Prévoir une période de refroidissement avant d'utiliser le pistolet ou la torche.



### LES CHAMPS MAGNÉTIQUES peuvent affecter les stimulateurs cardiaques.

- Porteurs de stimulateur cardiaque, restez à distance.
- Les porteurs d'un stimulateur cardiaque doivent d'abord consulter leur médecin avant de s'approcher des opérations de soudage à l'arc, de gougeage ou de soudage par points.



### LE BRUIT peut affecter l'ouïe.

Le bruit des processus et des équipements peut affecter l'ouïe.

- Porter des protections approuvés pour les oreilles si le niveau sonore est trop élevé.



### Si des BOUTEILLES sont endommagées, elles pourront exploser.

Des bouteilles de gaz protecteur contiennent du gaz sous haute pression. Si une bouteille est endommagée, elle peut exploser. Du fait que les bouteilles de gaz font normalement partie du procédé de soudage, les manipuler avec précaution.

- Protéger les bouteilles de gaz comprimé d'une chaleur excessive, des chocs mécaniques, du laitier, des flammes ouvertes, des étincelles et des arcs.
- Placer les bouteilles debout en les fixant dans un support stationnaire ou dans un porte-bouteilles pour les empêcher de tomber ou de se renverser.
- Tenir les bouteilles éloignées des circuits de soudage ou autres circuits électriques.
- Ne jamais placer une torche de soudage sur une bouteille à gaz.
- Une électrode de soudage ne doit jamais entrer en contact avec une bouteille.
- Ne jamais souder une bouteille pressurisée – risque d'explosion.
- Utiliser seulement des bouteilles de gaz protecteur, régulateurs, tuyaux et raccords convenables pour cette application spécifique; les maintenir ainsi que les éléments associés en bon état.
- Ne pas tenir la tête en face de la sortie en ouvrant la soupape de la bouteille.
- Maintenir le chapeau de protection sur la soupape, sauf en cas d'utilisation ou de branchement de la bouteille.
- Lire et suivre les instructions concernant les bouteilles de gaz comprimé, les équipements associés et les publications P-1 CGA énumérées dans les normes de sécurité.



## 1.3 Dangers supplémentaires en relation avec l'installation, le fonctionnement et la maintenance



### Risque D'INCENDIE OU D'EXPLOSION.

- Ne pas placer l'appareil sur, au-dessus ou à proximité de surfaces inflammables.
- Ne pas installer l'appareil à proximité de produits inflammables
- Ne pas surcharger l'installation électrique – s'assurer que l'alimentation est correctement dimensionnée et protégée avant de mettre l'appareil en service.

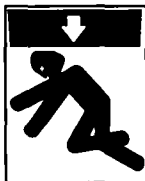

### LA CHUTE DE L'APPAREIL peut blesser.

- Utiliser l'anneau de levage uniquement pour soulever l'appareil, **NON PAS** les chariot, les bouteilles de gaz ou tout autre accessoire.
- Utiliser un engin d'une capacité appropriée pour soulever l'appareil.
- En utilisant des fourches de levage pour déplacer l'unité, s'assurer que les fourches sont suffisamment longues pour dépasser du côté opposé de l'appareil.

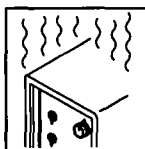

### L'EMPLOI EXCESSIF peut SURCHAUFFER L'ÉQUIPEMENT.

- Prévoir une période de refroidissement, respecter le cycle opératoire nominal.
- Réduire le courant ou le cycle opératoire avant de recommencer le soudage.
- Ne pas obstruer les passages d'air du poste.

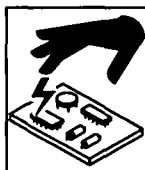

### LES CHARGES ÉLECTROSTATIQUES peuvent endommager les circuits imprimés.

- Établir la connexion avec la barrette de terre avant de manipuler des cartes ou des pièces.
- Utiliser des pochettes et des boîtes antistatiques pour stocker, déplacer ou expédier des cartes de circuits imprimés.



### DES ORGANES MOBILES peuvent provoquer des blessures.

- Ne pas s'approcher des organes mobiles.
- Ne pas s'approcher des points de coïncement tels que des rouleaux de commande.



### LES FILS DE SOUDAGE peuvent provoquer des blessures.

- Ne pas appuyer sur la gachette avant d'en avoir reçu l'instruction.
- Ne pas diriger le pistolet vers soi, d'autres personnes ou toute pièce mécanique en engageant le fil de soudage.



### DES ORGANES MOBILES peuvent provoquer des blessures.

- Rester à l'écart des organes mobiles comme le ventilateur.
- Maintenir fermés et fixement en place les portes, panneaux, recouvrements et dispositifs de protection.

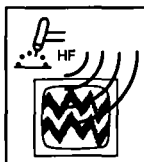

### LE RAYONNEMENT HAUTE FRÉQUENCE (H.F.) risque de provoquer des interférences.

- Le rayonnement haute fréquence peut provoquer des interférences avec les équipements de radio-navigation et de communication, les services de sécurité et les ordinateurs.
- Demander seulement à des personnes qualifiées familiarisées avec des équipements électroniques de faire fonctionner l'installation.
- L'utilisateur est tenu de faire corriger rapidement par un électricien qualifié les interférences résultant de l'installation.
- Si le FCC signale des interférences, arrêter immédiatement l'appareil.
- Effectuer régulièrement le contrôle et l'entretien de l'installation.
- Maintenir soigneusement fermés les portes et les panneaux des sources de haute fréquence, maintenir les éclateurs à une distance correcte et utiliser une terre et un blindage pour réduire les interférences éventuelles.



### LE SOUDAGE À L'ARC risque de provoquer des interférences.

- L'énergie électromagnétique risque de provoquer des interférences pour l'équipement électronique sensible tel que les ordinateurs et l'équipement commandé par ordinateur tel que les robots.
- Veiller à ce que tout l'équipement de la zone de soudage soit compatible électromagnétiquement.
- Pour réduire la possibilité d'interférence, maintenir les câbles de soudage aussi courts que possible, les grouper, et les poser aussi bas que possible (ex. par terre).
- Veiller à souder à une distance de 100 mètres de tout équipement électronique sensible.
- Veiller à ce que ce poste de soudage soit posé et mis à la terre conformément à ce mode d'emploi.
- En cas d'interférences après avoir pris les mesures précédentes, il incombe à l'utilisateur de prendre des mesures supplémentaires telles que le déplacement du poste, l'utilisation de câbles blindés, l'utilisation de filtres de ligne ou la pose de protecteurs dans la zone de travail.



### LES CHAMPS MAGNÉTIQUES peuvent affecter les stimulateurs cardiaques.

- Porteurs de stimulateur cardiaque, restez à distance.
- Les porteurs d'un stimulateur cardiaque doivent d'abord consulter leur médecin avant de s'approcher des opérations de soudage à l'arc, de gougeage ou de soudage par points.



## 1.4 Principales normes de sécurité

*Safety in Welding and Cutting*, norme ANSI Z49.1, de l'American Welding Society, 550 N.W. Lejeune Rd, Miami FL 33126

*Safety and Health Standards*, OSHA 29 CFR 1910, du Superintendent of Documents, U.S. Government Printing Office, Washington, D.C. 20402.

*Recommended Safe Practice for the Preparation for Welding and Cutting of Containers That Have Held Hazardous Substances*, norme AWS F4.1, de l'American Welding Society, 550 N.W. Lejeune Rd, Miami FL 33126

*National Electrical Code*, NFPA Standard 70, de la National Fire Protection Association, Batterymarch Park, Quincy, MA 02269.

*Safe Handling of Compressed Gases in Cylinders*, CGA Pamphlet P-1, de la Compressed Gas Association, 1235 Jefferson Davis Highway, Suite 501, Arlington, VA 22202.

*Règles de sécurité en soudage, coupage et procédés connexes*, norme CSA W117.2, de l'Association canadienne de normalisation, vente de normes, 178 Rexdale Boulevard, Rexdale (Ontario) Canada M9W 1R3.

*Safe Practices For Occupation And Educational Eye And Face Protection*, norme ANSI Z87.1, de l'American National Standards Institute, 1430 Broadway, New York, NY 10018.

*Cutting and Welding Processes*, norme NFPA 51B, de la National Fire Protection Association, Batterymarch Park, Quincy, MA 02269.

## 1.5 Information sur les champs électromagnétiques

Données sur le soudage électrique et sur les effets, pour l'organisme, des champs magnétiques basse fréquence

L'extrait suivant est tiré des conclusions générales du document intitulé *Biological Effects of Power Frequency Electric & Magnetic Fields – Background Paper, OTA-BP-E-53 (Washington DC : U.S. Government Printing Office, mai 1989)*, publié par le Office of Technology Assessment du Congrès américain : «... il existe maintenant d'abondantes données scientifiques compilées à la suite d'expériences sur la cellule ou d'études sur des animaux et des humains, qui montrent clairement que les champs électromagnétiques basse fréquence peuvent avoir des effets sur l'organisme et même y produire des transformations. Même s'il s'agit de travaux de très grande qualité, les résultats sont complexes. Cette démarche scientifique ne nous permet pas d'établir un tableau d'ensemble cohérent. Pire encore, elle ne nous permet pas de tirer des conclusions finales concernant les risques éventuels, ni d'offrir des conseils sur les mesures à prendre pour réduire sinon éliminer les risques éventuels». (Traduction libre)

Afin de réduire les champs électromagnétiques dans l'environnement de travail, respecter les consignes suivantes :

- 1 Garder les câbles ensemble en les torsadant ou en les attachant avec du ruban adhésif.
- 2 Mettre tous les câbles du côté opposé de l'opérateur.
- 3 Ne pas courber pas et ne pas entourer pas les câbles autour de vous.
- 4 Garder le poste de soudage et les câbles le plus loin possible de vous.
- 5 Relier la pince de masse le plus près possible de la zone de soudure.

### Consignes relatives aux stimulateurs cardiaques :

Les consignes mentionnées précédemment font partie de celles destinées aux personnes ayant recours à un stimulateur cardiaque. Veuillez consulter votre médecin pour obtenir plus de détails.

10/10/10



# 2. Introduction

## 2.1 Specifications

Rating	Input Power	Touch Sense Voltage	Input Power Cord	Overall Dimensions	Weight
800 A At 100% Duty Cycle	115 VAC, 2 A, 60 Hz	170 VDC, 5 mA	10 ft (2.5 m)	Length: 15-1/2 in (394 mm) Width: 12-5/8 in (321 mm) Height: 4-1/2 in (114 mm)	15-1/2 lb (7 kg)

## 2.2 Duty Cycle



Duty cycle is percentage of 10 minutes that unit can operate at rated load without overheating.

▲ Exceeding duty cycle can damage unit and void warranty.



Continuous Welding

# 3. Installation

## 3.1 DIP Switch Setting for Welding Power Source Selection

ST-801 885

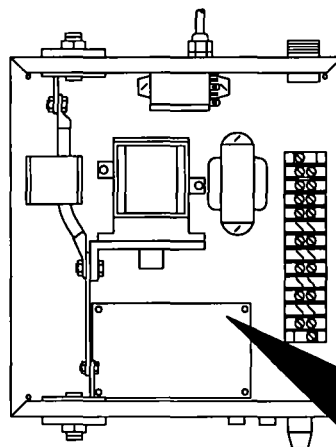

X Means switch position is factory set.

■ Means switch position can be changed.

### Welding Power Source Selection

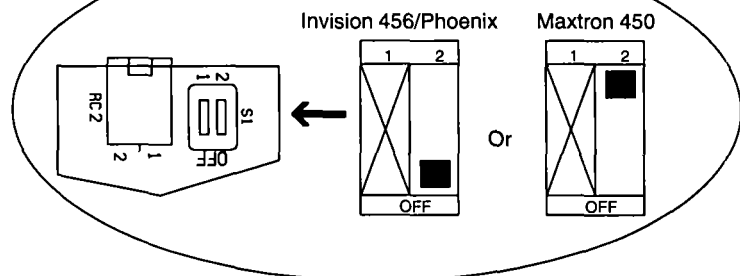

Tools Needed:

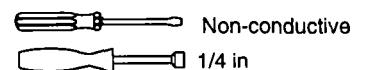



### 3.2 Weld Cable Connections

ST-801 886



- 1 Weld Terminal On Rear Of Unit.

Connect weld cable from welding power source to weld terminal on rear of unit.

- 2 Weld Terminal On Front Of Unit

Connect weld cable from wire drive assembly to weld terminal on front of unit.

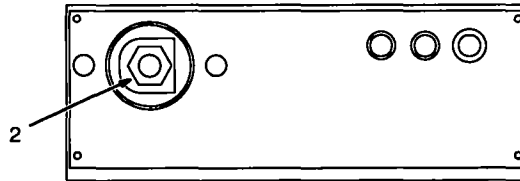
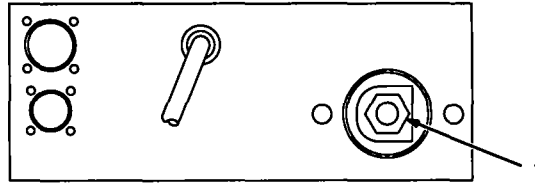

Tools Needed:

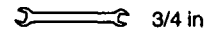

3/4 in

### 3.3 Receptacle RC1 Connection

Ref. ST-801 886 / Ref. ST-801 853

- 1 Touch Sensor Rear Panel
- 2 Receptacle RC1
- 3 Robotic Interface II Rear Panel
- 4 Receptacle RC33

Connect supplied interconnecting cable between RC1 on Touch Sensor and RC33 on Robotic Interface.

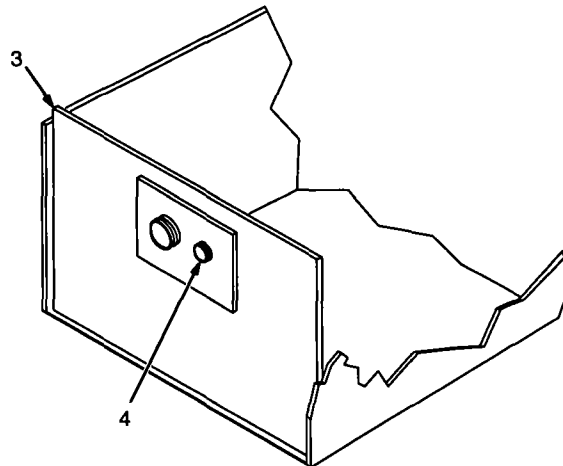
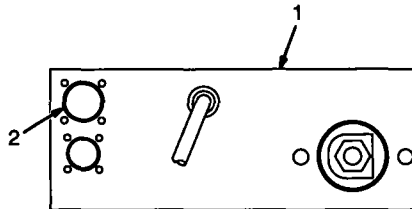



### 3.4 Connecting Voltage Sense Leads

ST-800 962-A / Ref. ST-801 886

▲ Do not connect voltage sense cord to Robotic Interface II when using touch sensing function.

1 Robotic Interface II Rear Panel

2 4-Pin Receptacle

Disconnect plug on end of voltage sensing cord from 4-pin receptacle.

3 Touch Sensor Rear Panel

4 Voltage Sensing Receptacle

Connect voltage sensing plug to receptacle on Touch Sensor rear panel.

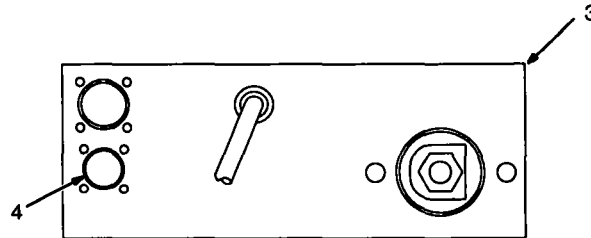
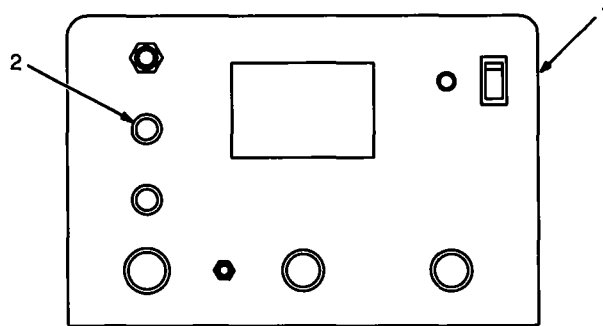

### 3.5 Connecting Input Power

ST-801 884



1 115 VAC Cord/Plug

2 115 VAC Grounded Receptacle

Connect input power plug to welding power source or other 115 volts ac receptacle.

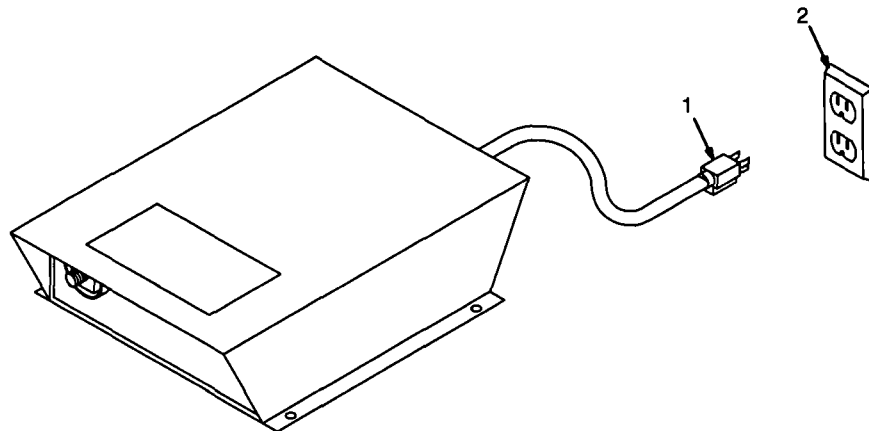



# 4. Operation

## 4.1 Touch Sensor Operation

ST-801 884 / SB-186 016



### 1 Input Power Pilot Light

Pilot light goes on when the unit is connected to a proper 115 vac power supply.

The Robotic Interface II sends a 115 vac signal to the Touch Sensor to close the contactor before welding begins. The contactor remains closed until the welding current drops below 15 amperes which is sensed by reed switch CR2. When no weld current is detected, the contactor deenergizes.

### 2 Touch Sensor Pilot Light

Pilot light goes on when 170 vdc is present on voltage sense leads.

The Touch Sensor receives a signal from the robot controller to begin the touch sensing operation. The contactor deenergizes to prevent any low impedance path through the welding power source. The Touch Sensor provides 170 vdc to the voltage sense leads. When less than 1.5k ohms of resistance is detected, a signal is sent to the robot controller indicating a touch by the welding wire.

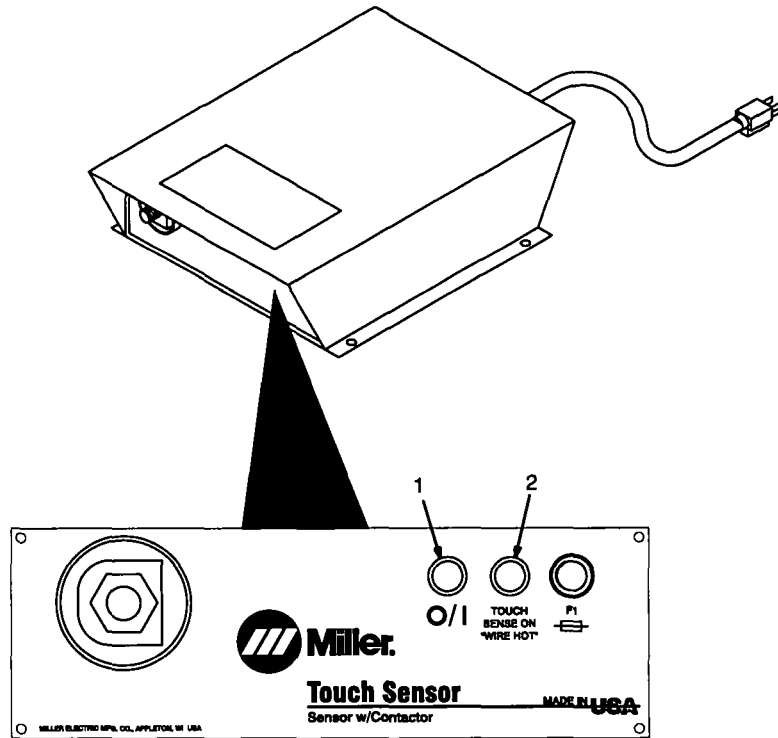

# 5. Maintenance and Troubleshooting

## 5.1 Routine Maintenance



3 Months

Replace damaged or unreadable labels.



Clean and tighten weld terminals.

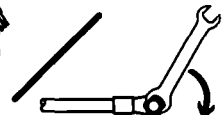

Repair or replace cracked cables and cords.

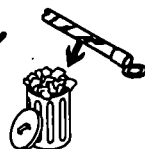
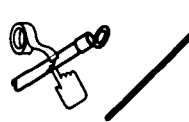

6 Months

Blow out or vacuum inside.







## 5.2 Overload Protection

Ref. ST-801 886 / Ref. ST-800 185-A



F1 protects unit from overload. If F1 opens, the unit shuts down. To check or change F1, proceed as follows:

- 1 Fuse Holder Cover
- 2 Fuse F1 (See Parts List For Rating)

Insert new fuse into cover, and install fuse with cover by pressing and turning cover clockwise.

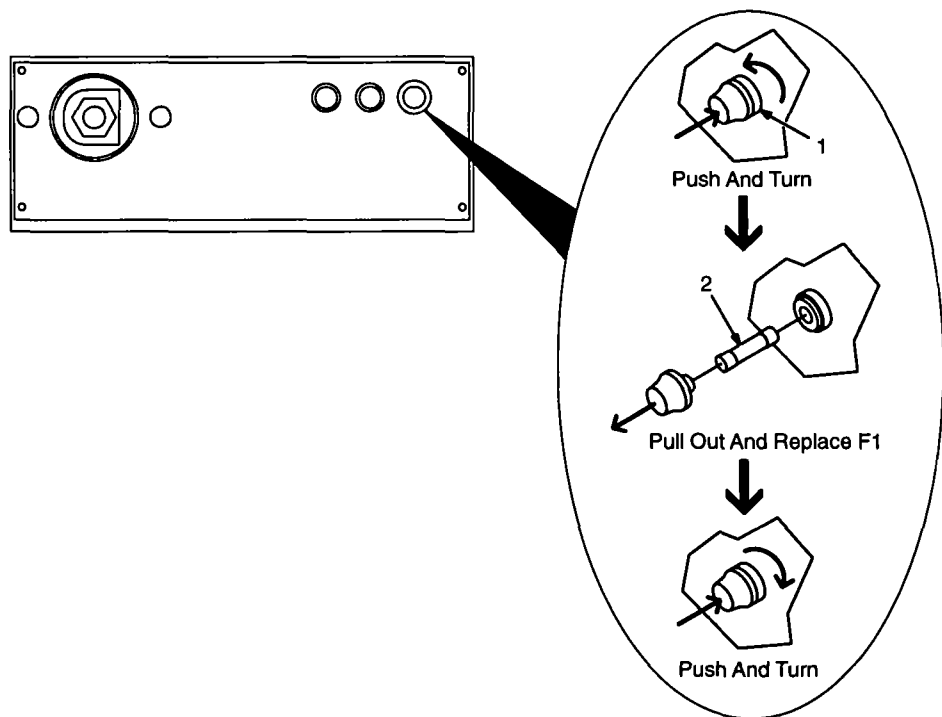

## 5.3 Troubleshooting



Trouble	Remedy
Unit does not work and pilot light PL1 does not turn on.	Be sure input power cord is plugged into energized receptacle on welder or wall. (see Section 3.5).
	Check protective fuses or circuit breaker, and replace or reset if necessary.
	Check fuse F1 and replace if necessary (see Section 5.2).
Touch sensor function inoperative and pilot light PL2 does not turn off.	Check connection of voltage sense leads.
	Have Factory Authorized Service Agent check touch sensing circuit.
Contactors W does not close before beginning welding operation.	Have Factory Authorized Service Agent check relay CR1 and contactor W, and replace if necessary.
Contactors W does not open after welding operation ends.	Have Factory Authorized Service Agent check reed relay CR2 and contactor W, and replace if necessary.



# 6. Electrical Diagram

## 6.1 Circuit Diagram

SB-186 072

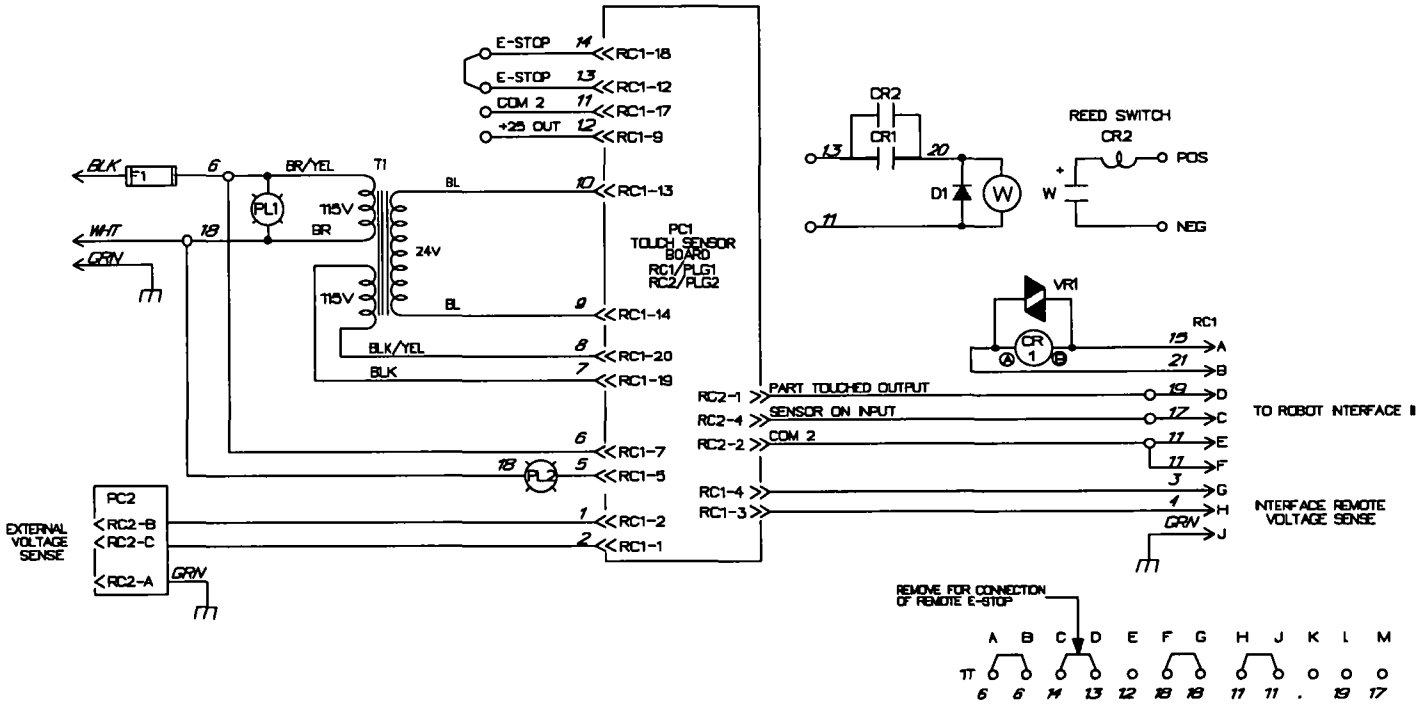



# Notes



# 7. Parts List

## 7.1 Complete Assembly

ST-801 887

 Hardware is common and not available unless listed.

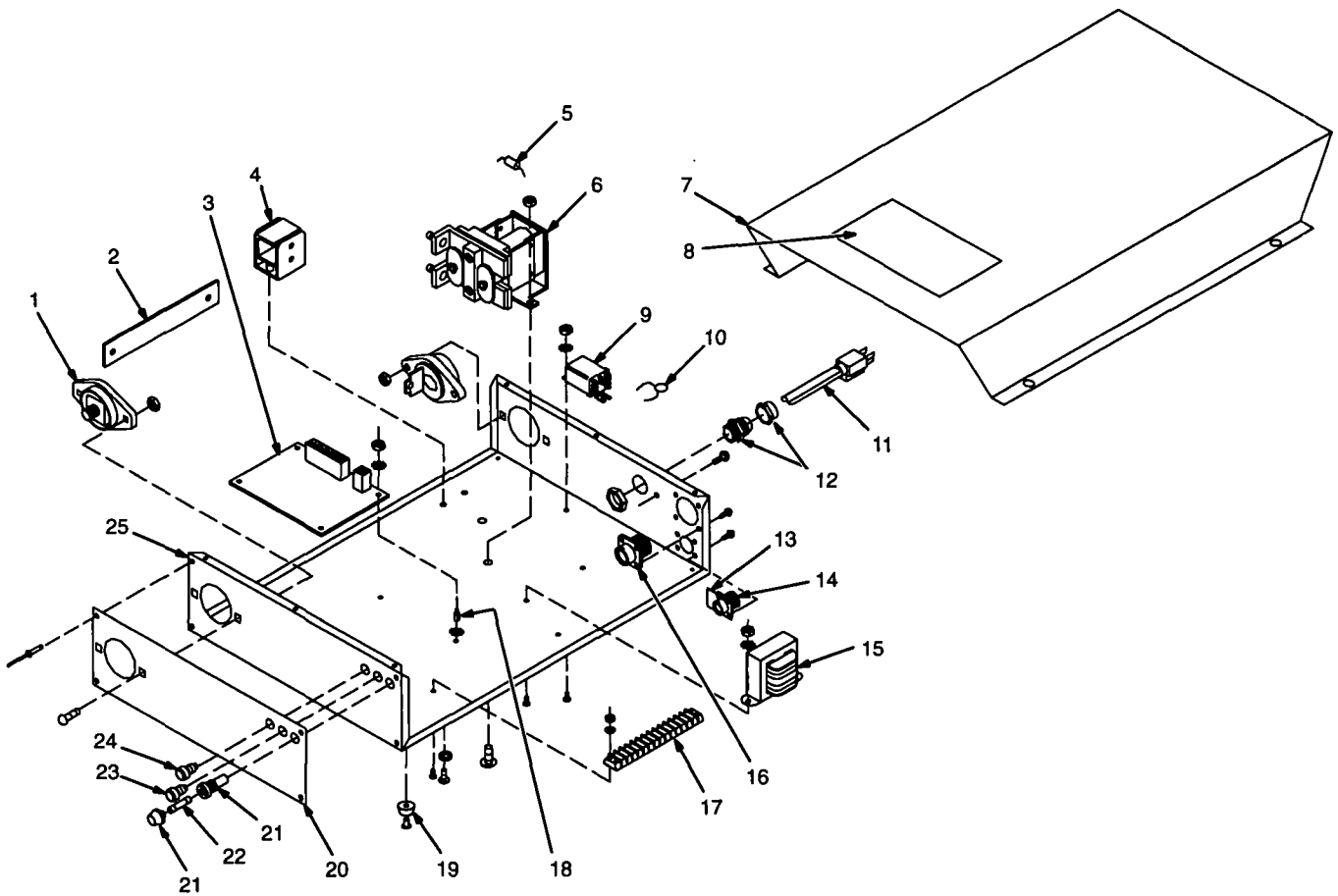





Item No.	Dia. Mkgs.	Part No.	Description	Quantity
1		182 665	... TERMINAL, pwr output neutral	2
2		186 098	... BUS BAR, contactor to output	1
3	PC1	174 573	... CIRCUIT CARD, touch sensor	1
	PLG1	162 382	... CONNECTOR & SOCKETS	1
	PLG2	115 094	... CONNECTOR & SOCKETS	1
4	CR2	186 102	... SWITCH, reed	1
5	D1	184 193	... DIODE, w/terminals	1
6	W	185 846	... CONTACTOR, 24VDC SPST 600	1
7		+185 629	... COVER	1
8		134 327	... LABEL, warning general precautionary	1
9	CR1	059 266	... RELAY, encl 120VAC DPDT	1
10	VR1	181 430	... VARISTOR, w/lugs	1
11		186 100	... CABLE, power	1
12		139 042	... BUSHING, strain relief	1
13	PC2	134 560	... CIRCUIT CARD, filter	1
14	RC2	076 624	... CONNECTOR, circ 4pin	1
15	T1	186 104	... TRANSFORMER, control 115/115-24	1
16	RC1	089 646	... CONNECTOR, circ 10pin	1
17	1T	038 783	... BLOCK, term 20A 12P	1
18		134 201	... STAND-OFF SUPPORT, PC card	4
19		019 663	... MOUNT, nprn	4
20		186 016	... NAMEPLATE	1
21		046 432	... HOLDER, fuse mintr	1
22	F1	*012 658	... FUSE, mintr gl slo blo 2A 250V	1
23	PL2	074 188	... LIGHT, ind red	1
24	PL1	163 562	... LIGHT, ind white	1
25		185 628	... PANEL, front/bottom/sides	1
		120 357	... CABLE, interconnecting 25ft	1

+When ordering a component originally displaying a precautionary label, the label should also be ordered.

\* Recommended Spare Parts.

**To maintain the factory original performance of your equipment, use only Manufacturer's Suggested Replacement Parts. Model and serial number required when ordering parts from your local distributor.**



# TRUE BLUE<sup>®</sup>

## WARRANTY

Effective January 1, 1997  
(Equipment with a serial number preface of "KH" or newer)

This limited warranty supersedes all previous Miller warranties and is exclusive with no other guarantees or warranties expressed or implied.

**LIMITED WARRANTY** – Subject to the terms and conditions below, Miller Electric Mfg. Co., Appleton, Wisconsin, warrants to its original retail purchaser that new Miller equipment sold after the effective date of this limited warranty is free of defects in material and workmanship at the time it is shipped by Miller. **THIS WARRANTY IS EXPRESSLY IN LIEU OF ALL OTHER WARRANTIES, EXPRESS OR IMPLIED, INCLUDING THE WARRANTIES OF MERCHANTABILITY AND FITNESS.**

Within the warranty periods listed below, Miller will repair or replace any warranted parts or components that fail due to such defects in material or workmanship. Miller must be notified in writing within thirty (30) days of such defect or failure, at which time Miller will provide instructions on the warranty claim procedures to be followed.

Miller shall honor warranty claims on warranted equipment listed below in the event of such a failure within the warranty time periods. All warranty time periods start on the date that the equipment was delivered to the original retail purchaser, or one year after the equipment is sent to a North American distributor or eighteen months after the equipment is sent to an International distributor.

1. 5 Years Parts – 3 Years Labor
  - Original main power rectifiers
  - Inverters (input and output rectifiers only)
2. 3 Years — Parts and Labor
  - Transformer/Rectifier Power Sources
  - Plasma Arc Cutting Power Sources
  - Semi-Automatic and Automatic Wire Feeders
  - Inverter Power Supplies
  - Intellitig
  - Robots
  - Engine Driven Welding Generators  
(NOTE: Engines are warranted separately by the engine manufacturer.)
3. 1 Year — Parts and Labor
  - Motor Driven Guns
  - Process Controllers
  - Positioners and Controllers
  - Automatic Motion Devices
  - Orbital Weld Heads
  - IHPS Power Sources
  - Water Coolant Systems
  - HF Units
  - Grids
  - Spot Welders
  - Load Banks
  - SDX Transformers
  - Miller Cyclomatic Equipment
  - Running Gear/Trailers
  - Plasma Cutting Torches (except APT, ZIPCUT & PLAZCUT Models)
  - Deutz Engines (outside North America)
  - Field Options  
(NOTE: Field options are covered under True Blue<sup>®</sup> for the remaining warranty period of the product they are installed in, or for a minimum of one year — whichever is greater.)
4. 6 Months — Batteries
5. 90 Days — Parts and Labor
  - MIG Guns/TIG Torches
  - APT, ZIPCUT & PLAZCUT Model Plasma Cutting Torches
  - Remote Controls
  - Accessory Kits
  - Replacement Parts (No labor)

Miller's True Blue<sup>®</sup> Limited Warranty shall not apply to:

1. Items furnished by Miller, but manufactured by others, such as engines or trade accessories. These items are covered by the manufacturer's warranty, if any.
2. Consumable components; such as contact tips, cutting nozzles, contactors, brushes, slip rings, relays or parts that fail due to normal wear.
3. Equipment that has been modified by any party other than Miller, or equipment that has been improperly installed, improperly operated or misused based upon industry standards, or equipment which has not had reasonable and necessary maintenance, or equipment which has been used for operation outside of the specifications for the equipment.

**MILLER PRODUCTS ARE INTENDED FOR PURCHASE AND USE BY COMMERCIAL/INDUSTRIAL USERS AND PERSONS TRAINED AND EXPERIENCED IN THE USE AND MAINTENANCE OF WELDING EQUIPMENT.**

In the event of a warranty claim covered by this warranty, the exclusive remedies shall be, at Miller's option: (1) repair; or (2) replacement; or, where authorized in writing by Miller in appropriate cases, (3) the reasonable cost of repair or replacement at an authorized Miller service station; or (4) payment of or credit for the purchase price (less reasonable depreciation based upon actual use) upon return of the goods at customer's risk and expense. Miller's option of repair or replacement will be F.O.B., Factory at Appleton, Wisconsin, or F.O.B. at a Miller authorized service facility as determined by Miller. Therefore no compensation or reimbursement for transportation costs of any kind will be allowed.

**TO THE EXTENT PERMITTED BY LAW, THE REMEDIES PROVIDED HEREIN ARE THE SOLE AND EXCLUSIVE REMEDIES. IN NO EVENT SHALL MILLER BE LIABLE FOR DIRECT, INDIRECT, SPECIAL, INCIDENTAL OR CONSEQUENTIAL DAMAGES (INCLUDING LOSS OF PROFIT), WHETHER BASED ON CONTRACT, TORT OR ANY OTHER LEGAL THEORY.**

**ANY EXPRESS WARRANTY NOT PROVIDED HEREIN AND ANY IMPLIED WARRANTY, GUARANTY OR REPRESENTATION AS TO PERFORMANCE, AND ANY REMEDY FOR BREACH OF CONTRACT TORT OR ANY OTHER LEGAL THEORY WHICH, BUT FOR THIS PROVISION, MIGHT ARISE BY IMPLICATION, OPERATION OF LAW, CUSTOM OF TRADE OR COURSE OF DEALING, INCLUDING ANY IMPLIED WARRANTY OF MERCHANTABILITY OR FITNESS FOR PARTICULAR PURPOSE, WITH RESPECT TO ANY AND ALL EQUIPMENT FURNISHED BY MILLER IS EXCLUDED AND DISCLAIMED BY MILLER.**

Some states in the U.S.A. do not allow limitations of how long an implied warranty lasts, or the exclusion of incidental, indirect, special or consequential damages, so the above limitation or exclusion may not apply to you. This warranty provides specific legal rights, and other rights may be available, but may vary from state to state.

In Canada, legislation in some provinces provides for certain additional warranties or remedies other than as stated herein, and to the extent that they may not be waived, the limitations and exclusions set out above may not apply. This Limited Warranty provides specific legal rights, and other rights may be available, but may vary from province to province.

Warranty Questions?

Call  
**1-800-4-A-MILLER**  
for your local  
Miller distributor.





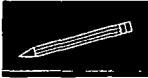

# Owner's Record

Please complete and retain with your personal records.

Model Name

Serial/Style Number

Purchase Date

(Date which equipment was delivered to original customer.)

Distributor

Address

City

State

Zip



## Resources Available

Always provide Model Name and Serial/Style Number.

Contact your Distributor for:

To locate distributor nearest you call  
1-800-4-A-Miller.

Welding Supplies and Consumables

Options and Accessories

Personal Safety Equipment

Service and Repair

Replacement Parts

Training (Schools, Videos, Books)

Owner's Manuals

Technical Manuals (Servicing Information  
and Parts)

Circuit Diagrams

Welding Process Handbooks

Contact the Delivering Carrier for:

For assistance in filing or settling claims,  
contact your distributor and/or equipment  
manufacturer's Transportation Department.

File a claim for loss or damage during ship-  
ment.

### Miller Electric Mfg. Co.

An Illinois Tool Works Company  
1635 West Spencer Street  
Appleton, WI 54914 USA

International Headquarters—USA  
Phone: 414-734-9821  
USA & Canada FAX: 414-735-4134  
International FAX: 414-735-4125

European Headquarters —  
United Kingdom  
Phone: 44 (0) 1625-525556  
FAX: 44 (0) 1625-537553

